

ZP3 series

型號：

① ② ③
ZP3 - 015 UM N



① 吸盤直徑 mm

015	Ø 1.5
02	Ø 2
035	Ø 3.5
04	Ø 4
06	Ø 6
08	Ø 8
10	Ø 10
13	Ø 13
16	Ø 16

② 吸盤形狀

UM	帶肋平型
B	風琴型(皺褶)

③ 吸盤材質

N	丁腈橡膠 NBR
S	矽橡膠
GN	抗靜電 NBR
GS	抗靜電矽橡膠

規格：

標示	材質	硬度	使用溫度範圍	顏色	膠體阻抗值
N	丁腈橡膠 NBR	A55/S	-26 °C ~ 120 °C	黑色	
S	矽橡膠	A55/S	-60 °C ~ 250 °C	乳白色	
GN	抗靜電丁腈橡膠	A70/S	-26 °C ~ 120 °C	黑色紅點	$10^5 \sim 10^7 \Omega / cm^3$
GS	抗靜電矽橡膠	A55/S	-60 °C ~ 250 °C	黑色紅點	$10^5 \sim 10^7 \Omega / cm^3$

形狀	直徑	Ø 1.5	Ø 2	Ø 3.5	Ø 4	Ø 6	Ø 8	Ø 10	Ø 13	Ø 16
	U 平型		●	●	●	---	---	---	---	---
UM 帶肋平型		---	---	---	●	●	●	●	●	●
B 風琴型(皺褶)		---	---	---	●	●	●	●	●	●

ZP3 series

外觀尺寸：

ZP3-015U (重量：0.1 g)

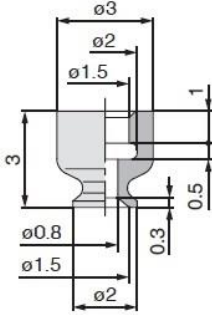

ZP3-02U (重量：0.1 g)

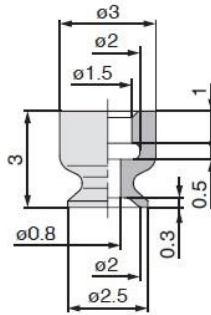

ZP3-035U (重量：0.1 g)

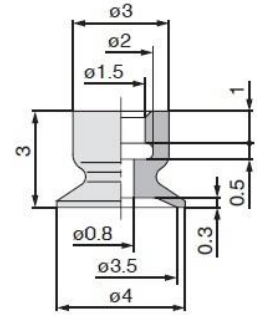

ZP3-04UM (重量：0.3 g)

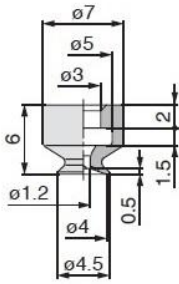

3-06UM (重量：0.3 g)

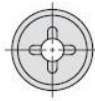
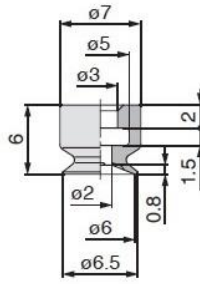

ZP3-08UM (重量：0.3 g)

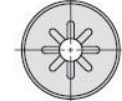
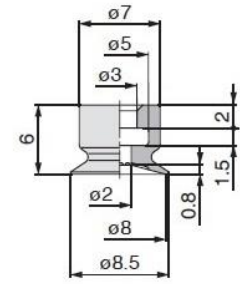

ZP3-10UM (重量：0.6 g)

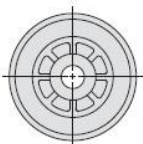
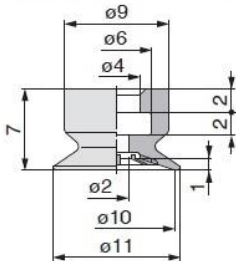

ZP3-13UM (重量：0.7 g)

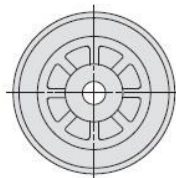
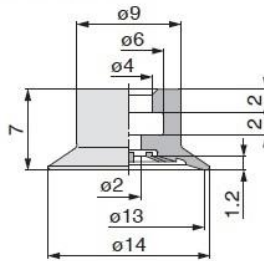

ZP3-16UM (重量：0.8 g)

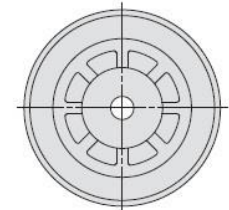
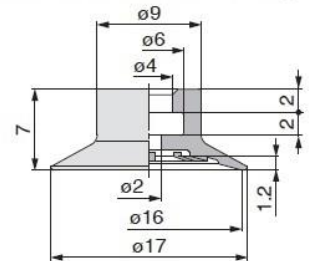

ZP3 series

ZP3-04B□ (重量 : 0.3 g)

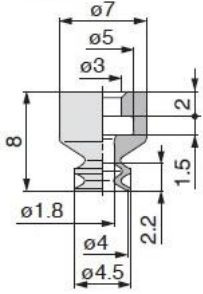

ZP3-06B□ (重量 : 0.3 g)

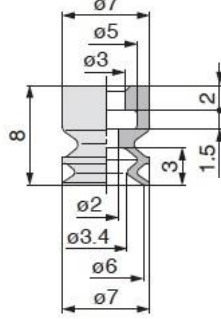

ZP3-08B□ (重量 : 0.4 g)

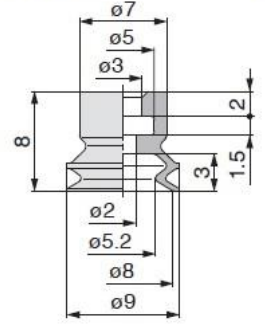

ZP3-10B□ (重量 : 0.8 g)

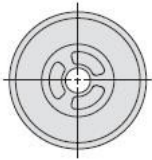
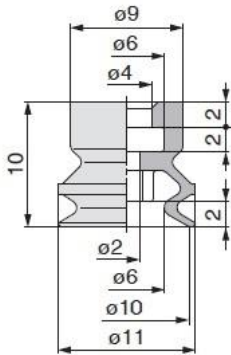

ZP3-13B□ (重量 : 1.0 g)

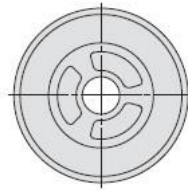
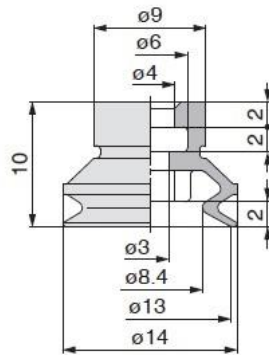

ZP3-16B□ (重量 : 1.1 g)

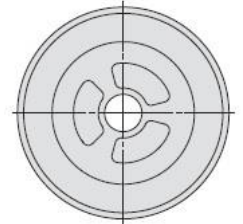
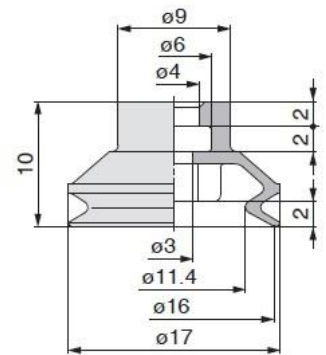

製作連接吸盤零件之尺寸

適用吸盤
04UM/06UM/08UM/04B/06B/08B

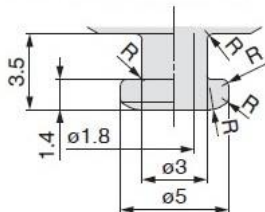

適用吸盤
10UM/13UM/16UM/10B/13B/16B

