

PAG Series

型號：單體吸盤

PAG - ① 10 - ② N



① 吸盤直徑

10	Ø 10
15	Ø 13
20	Ø 20
25	Ø 25
30	Ø 32
40	Ø 40
50	Ø 50

② 吸盤材質

N	丁腈橡膠 NBR
S	矽橡膠
NE	抗靜電 NBR
SE	抗靜電矽橡膠

標示	材質	硬度	使用溫度範圍	顏色	膠體阻抗值
N	丁腈橡膠 NBR	A55/S	-26°C~120°C	黑色	
S	矽橡膠	A55/S	-60°C~250°C	乳白色	
NE	抗靜電 NBR	A70/S	-26°C~120°C	黑色紅點	$10^5 \sim 10^7 \Omega/\text{cm}^2$
SE	抗靜電矽橡膠	A55/S	-60°C~250°C	黑色紅點	$10^5 \sim 10^7 \Omega/\text{cm}^2$

外觀尺寸：單體吸盤

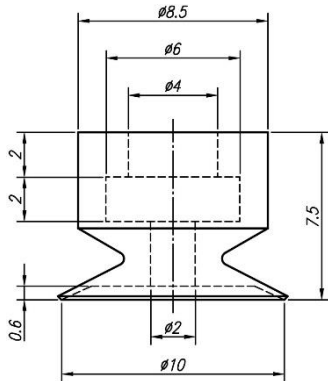

PAG-10

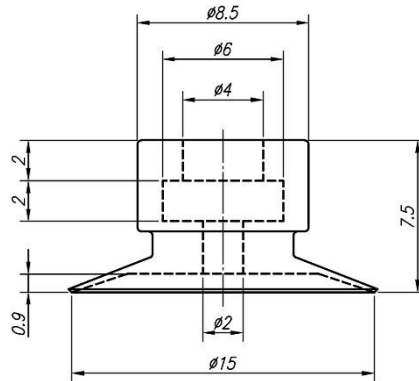

PAG-15

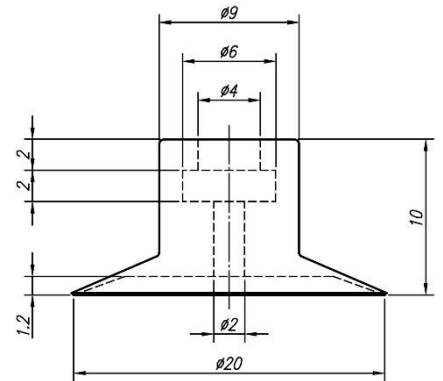

PAG-20

PAG Series

外觀尺寸：單體吸盤

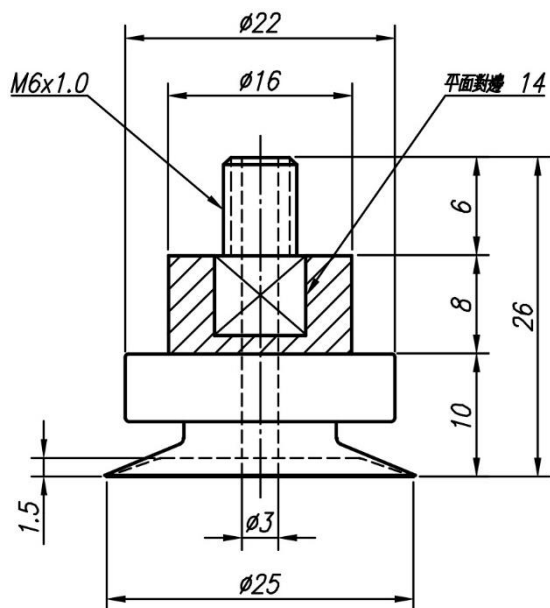

PAG-25

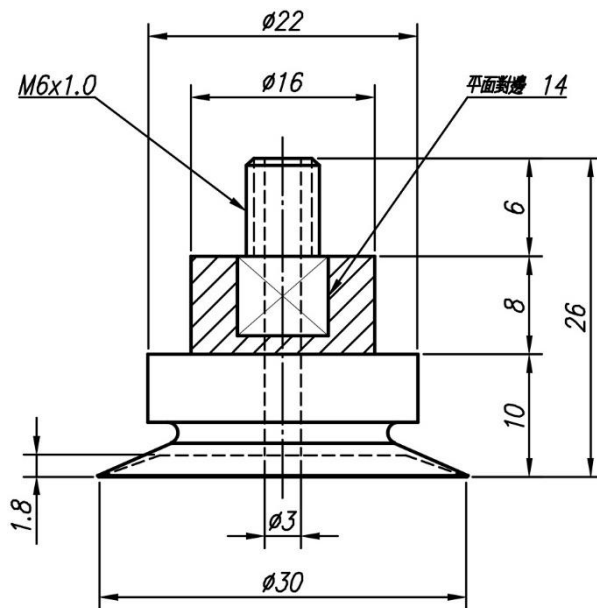

PAG-30

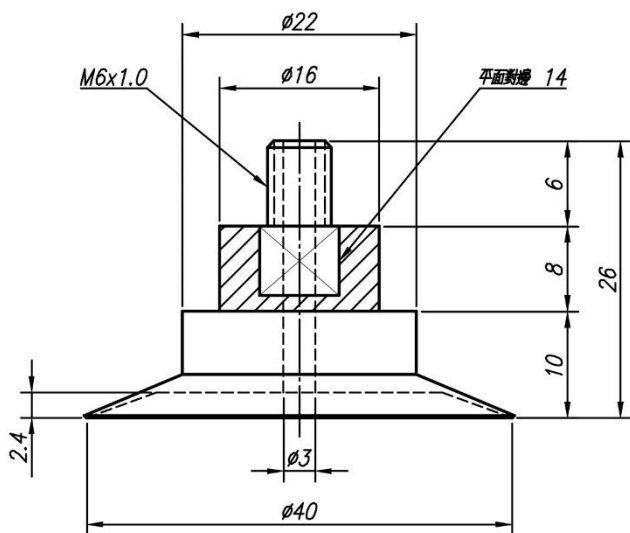

PAG-40

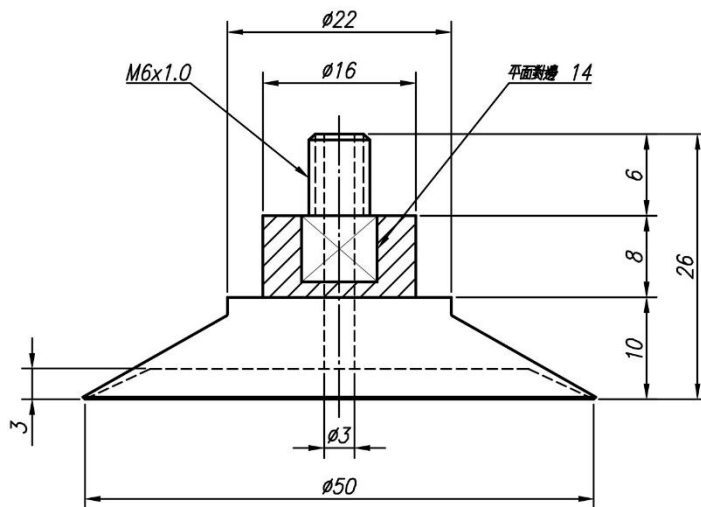

PAG-50